

The logo for 'fab ita' is located in the top right corner. It consists of the word 'fab' stacked above the word 'ita', both in a lowercase, sans-serif font. The text is contained within a thin black square border.

fab
ita

Unsuspected Future

Unsuspected Future

I prodotti hanno ricevuto prestigiosi riconoscimenti internazionali:

ADI Design Index, German Design Award, Good Design Chicago, iF Design Award, Premio Compasso d'oro, Sãlao Design.

The products have received prestigious international awards:

ADI Design Index, German Design Award, Good Design Chicago, iF Design Award, Premio Compasso d'oro, Sãlao Design.

Ordine has been awarded with Premio Compasso D'Oro 2022



Fabita è l'evoluzione di una realtà industriale con più di dieci anni di esperienza nel settore dell'induzione vetroceramica e delle cappe aspiranti.

Fabita is the evolution of an industrial firm with over 10 years of experience in the sector of induction and vitroceramic hobs and of extractor hoods.

Ricerca e innovazione sono alla base della filosofia progettuale dello studio Adriano Design, che esprime nei suoi progetti un approccio multidisciplinare, tecnologico e sperimentale.

Research and innovation are the cornerstone of Adriano Design studio philosophy, which expresses a multidisciplinary, technological and experimental approach in its projects.



Cucinare rimane una funzione fondamentale in casa, presente ormai anche nei moderni luoghi work metropolitan o nelle situazioni di vacanza, e allo stesso tempo gli spazi diventano sempre più piccoli, i comportamenti sociali nomadi, gli ambienti di vita ibridi: con la nuova gamma prodotto di Fabita la cucina si destruttura e i tradizionali arredi si evolvono in una serie di elementi liberi, leggeri, flessibili.

Grazie a un know-how che trae origine dalla specializzazione del distretto marchigiano in cui è collocata, tradizionalmente riconosciuto per la produzione di cucine ed elettrodomestici, Fabita rinnova radicalmente la sua proposta aziendale attraverso la collaborazione con Adriano Design. Il brand si inserisce così nella contemporaneità cogliendo le grandi trasformazioni in atto e segnando un cambio di approccio rispetto al design delle attrezzature per cucinare.

Cooking still plays a vital role at home, which is now present even in the modern metropolitan workplaces or in holiday situations, and at the same time spaces become increasingly smaller, social behaviours more nomadic, living environments more hybrid: with the new Fabita product range the kitchen deconstructs itself and turns traditional furniture into a series of free, light, flexible elements.

Thanks to a consolidated know-how acquired from the specialization of the Marche region, where it is placed, traditionally recognized for manufacturing kitchens and home appliances, Fabita radically renews its strategy through the collaboration with Adriano Design. The brand thus fits into contemporary design by seizing its the great transformations and marking an approach shift from the design of cooking facilities.

Induction hob Induzione	Ordine	06
	Ordine Mono	11
	Ordine Isola	13
	Sorpresa	18
	Ribalto	24
	Eccolo	30
	Comodo	34
	Comodo XL	39
	Comodissimo	43
	Bancone	46
	Tutto	50
	Mammamia	56

Induzione e cappa Induction hob and cooker hood	Cucinotta	64
--	-----------	----

Cappa Cooker hood	Enigma	68
	Epoca	72
	Linea	76
	Cassetta	80
	Pura	86
	Pura - Isola	91

Ordine

PATENT



Un elemento innovativo per cucinare formato da due piastre a induzione che lasciano libero il piano cucina: quando serve è possibile prenderne una o entrambe, per poi riporle nuovamente a muro una volta terminato l'utilizzo.

Le zone di cottura indipendenti l'una dall'altra permettono di utilizzare in contemporanea due pentole anche di grandi dimensioni, mentre con i fuochi convenzionali la distanza tra le zone risulta molto vincolante.

Ordine rappresenta una soluzione salvaspazio altamente flessibile che per la sua connotazione freestanding può facilmente migrare tra gli ambienti anche nel caso di riconfigurazioni di spazi e arredi, cambiamenti di layout interno, ecc...

An innovative cooking element made up of two induction plates that allow the kitchen top to be kept free: when needed, you can use one plate or both and then just simply put them back on the wall once you have finished cooking.

The independent cooking zones allow two large pans to be used simultaneously - while the distance between zones is very binding with conventional burners.

Ordine represents a highly flexible space-saving solution, which thanks to its free-standing 'character', can easily find its place in other domestic environments, even in the case of the restyling of furnishings and spaces, changes in internal layout, etc.

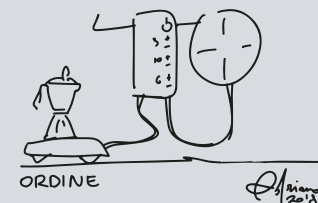





Piano induzione

Induction hob

Ordine Mono



Ordine è disponibile anche in versione a singola piastra con staffa per fissaggio a parete.

Ordine is also available in a single plate version with wall bracket.



Induction hob

Piano induzione

Ordine Isola



Ordine può essere anche da appoggio con basi in legno o metallo.

Order can also be countertop with wooden or metal bases.





Bianco / Inox



Bianco



Bianco / Wood / Inox

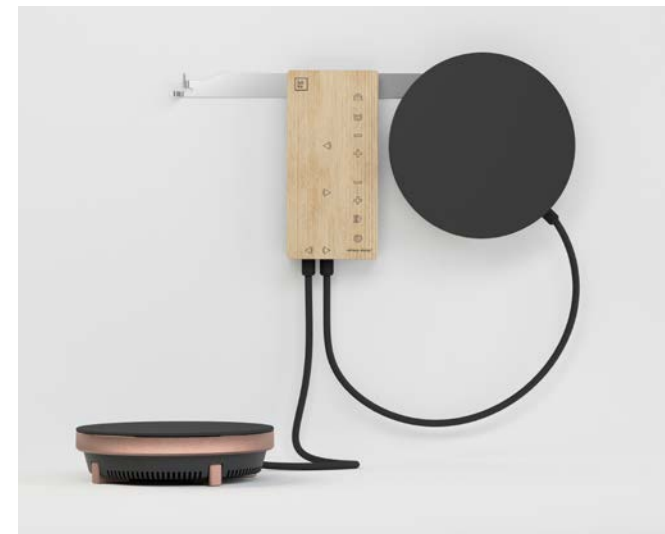

Nero / Wood / Rame



Bianco / Ottone



Leopard



Nero / Inox



Nero / Rame



Lion



Zebra



Nero / Ghisa



Nero / Ottone

Sorpresa

PATENT



Un piano cottura sorprendente, perché totalmente decostruito e senza vincoli: sottili dischi di diametro diverso (fino a un massimo di 6) sono alloggiati su una base in legno, da cui si possono estrarre al bisogno. I singoli piani, la scheda di potenza e l'interfaccia utente sono separati e remotizzati.

A surprising hob, completely deconstructed and without any constraints: thin disks of various diameters (up to a maximum of 6) are housed on a wooden base, from which they can be extracted as needed.

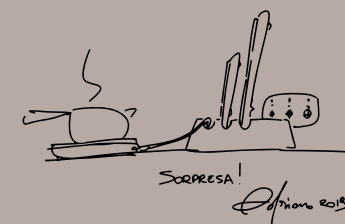





Il controllo avviene con comando touch, in modo da poter gestire la cottura liberamente, con uno o più piani in contemporanea. Totalmente decostruito e senza vincoli.

Control is done with an touch control, it allows you to cook freely and remotely, using one or more hobs at the same time. Completely deconstructed and without any constraints.

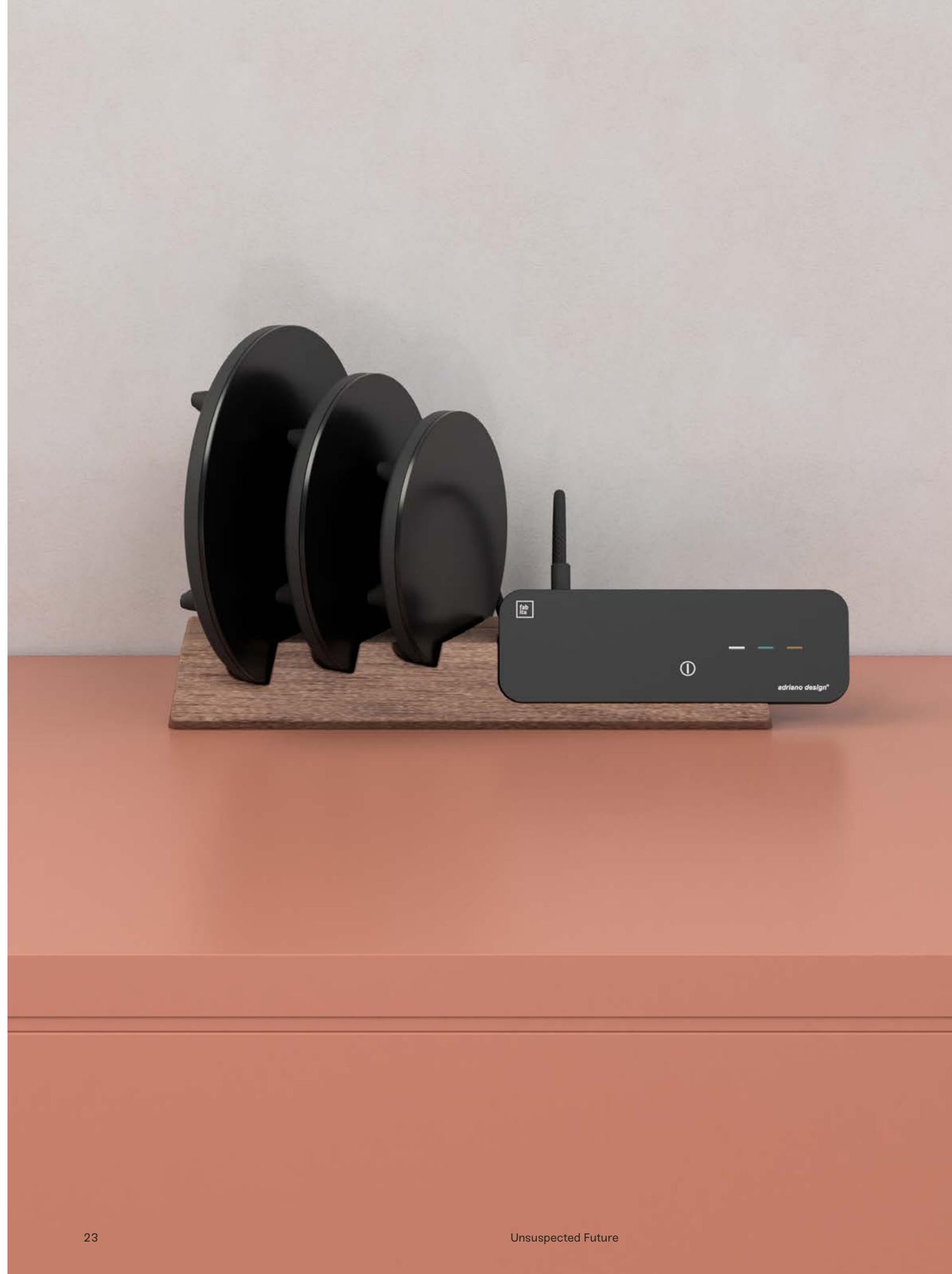
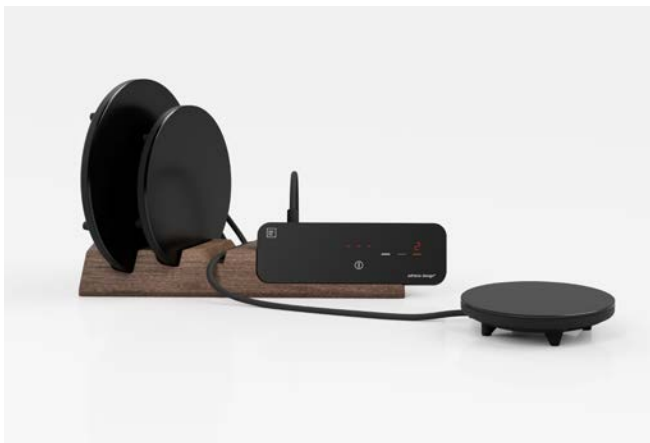

Ribalto

PATENT



Piano a induzione super sottile, per la sua leggerezza può essere facilmente sollevato quando non serve: questo semplice gesto permette di utilizzare il top della cucina sia per la preparazione che per il consumo dei cibi.

Utile negli ambienti di piccole dimensioni dove ogni centimetro è prezioso o in contesti non convenzionali che non necessitano di elementi cucina fissi.

This super thin induction hob is so lightweight that it can be easily raised when not needed; this simple gesture allows the kitchen top to be used for both food preparation and dining.

Ideal for small spaces where every inch counts or for unconventional contexts that do not require fixed kitchen elements.

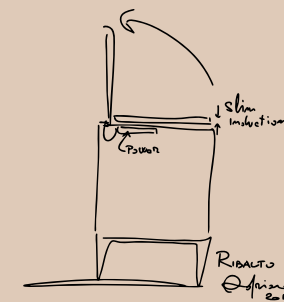



La base è in acciaio inox satinato, con basamento inferiore in legno di frassino, con la pratica maniglia in cuoio utile per afferrarlo e ribaltarlo.

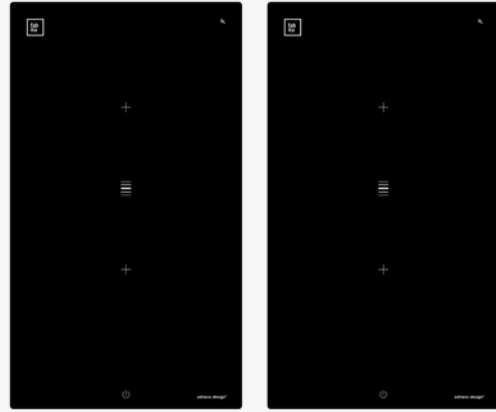

The base is made in brushed stainless steel, with a lower under-frame in ash wood provided with a practical leather handle that is useful for grasping and tipping it over.

Il piano a induzione ha uno spessore di soli 30 mm grazie al brevetto Fabita che remotizza la scheda di potenza sotto il piano.

The induction hob is just 30 mm thick, thanks to the Fabita patent that remotely places the power board under the hob.

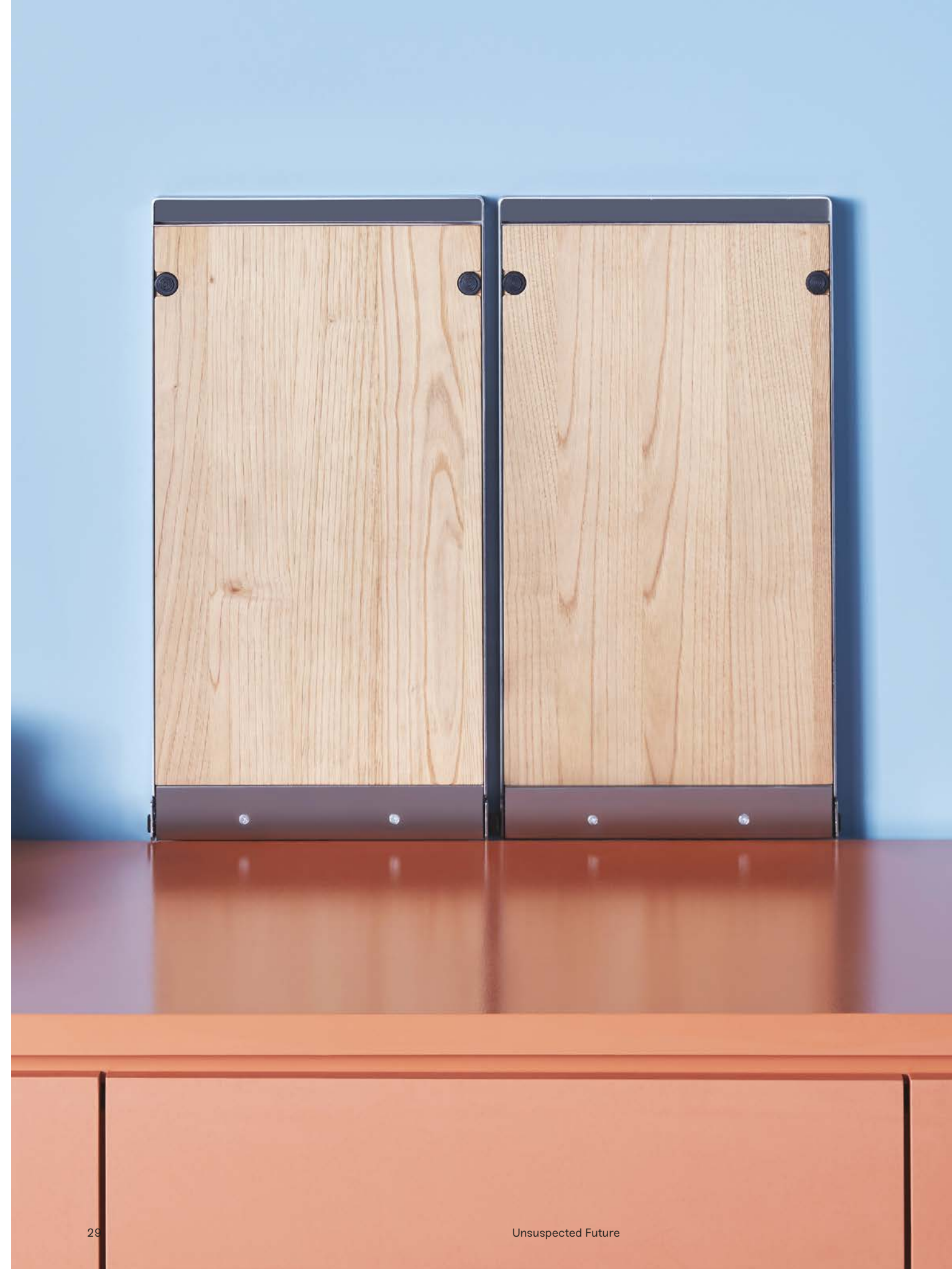
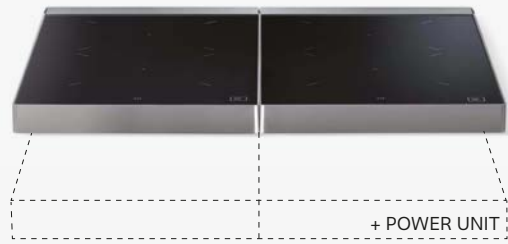

Eccolo



Piano cottura a induzione monofuoco: la piastra tonda poggia su uno stelo a un'altezza di 70 cm ed è sorretta a terra da una base tonda che funge anche da avvolgicavo.

La pratica manopola frontale permette di modulare la potenza in modo analogico, rendendo intuitiva la gestualità, mentre i programmi si azionano sfiorando i comandi touch retroilluminati posizionati sul piano cottura.

La struttura è realizzata interamente in alluminio e il piano cottura è in vetroceramica: leggero e dinamico, Eccolo può essere trasportato agevolmente da un ambiente all'altro e anche all'esterno, per cucinare ovunque. Grazie alla sua configurazione stand alone, si presta perfettamente per le preparazioni veloci o per ultimare le cotture favorendo il servizio al tavolo, come nelle sale da tè o nei coffee lab per le degustazioni.

A single zone induction hob: the round plate leans on a stem at a height of almost 27,5 inches and it is held up on the ground by a round base serving also as a cable drum. The frontal easy-to-grab knob allows to analogically modulate the power, making the gesture intuitive, while it is possible to activate the programs through the backlit touch controls placed on the cooking hob.

The structure is completely made in aluminium and the cooking hob is in glass ceramic: light and dynamic, Eccolo can be easily moved from one place to another, also outdoors, to cook everywhere. Thanks to its stand alone configuration, it lends itself perfectly to quick preparations and to complete cookings allowing the service at the table, as in tea rooms and coffee labs for tasting itineraries.





Comodo



Quasi un archetipo del carrello contenitore che si trasforma in una vera e propria mini-cucina portatile: la struttura reticolare in metallo sostiene una piastra a induzione con due zone cottura, una barra per appendere utensili e due ripiani sottostanti in legno di frassino.

Almost an archetype of the container trolley that transforms into a real portable mini-kitchen: the metal lattice structure holds an induction plate with two cooking zones, a bar for hanging utensils and two underlying shelves made in ash wood.







Piano induzione

Induction hob

Comodo XL



Nella versione XL la zona cottura prosegue filo top con un piano di lavoro sempre in legno. Una soluzione minimale dalle grandi funzionalità che può facilmente migrare tra gli ambienti.

In the XL version the cooking area continues flush with a wooden worktop. A minimalist solution with great features that can easily migrate between various environments.



**BLOCK YEAR PLANNER
2020**

JAN	1	2	3	4	5	6	7	8	9	10	11	12	13	14	15	16	17	18	19	20	21	22	23	24	25	26	27	28	29	30	31
FEB	1	2	3	4	5	6	7	8	9	10	11	12	13	14	15	16	17	18	19	20	21	22	23	24	25	26	27	28	29		
MAR	1	2	3	4	5	6	7	8	9	10	11	12	13	14	15	16	17	18	19	20	21	22	23	24	25	26	27	28	29	30	31
APR	1	2	3	4	5	6	7	8	9	10	11	12	13	14	15	16	17	18	19	20	21	22	23	24	25	26	27	28	29	30	
MAY	1	2	3	4	5	6	7	8	9	10	11	12	13	14	15	16	17	18	19	20	21	22	23	24	25	26	27	28	29	30	31
JUN	1	2	3	4	5	6	7	8	9	10	11	12	13	14	15	16	17	18	19	20	21	22	23	24	25	26	27	28	29	30	
JUL	1	2	3	4	5	6	7	8	9	10	11	12	13	14	15	16	17	18	19	20	21	22	23	24	25	26	27	28	29	30	31
AUG	1	2	3	4	5	6	7	8	9	10	11	12	13	14	15	16	17	18	19	20	21	22	23	24	25	26	27	28	29	30	31
SEP	1	2	3	4	5	6	7	8	9	10	11	12	13	14	15	16	17	18	19	20	21	22	23	24	25	26	27	28	29	30	
OCT	1	2	3	4	5	6	7	8	9	10	11	12	13	14	15	16	17	18	19	20	21	22	23	24	25	26	27	28	29	30	31
NOV	1	2	3	4	5	6	7	8	9	10	11	12	13	14	15	16	17	18	19	20	21	22	23	24	25	26	27	28	29	30	
DEC	1	2	3	4	5	6	7	8	9	10	11	12	13	14	15	16	17	18	19	20	21	22	23	24	25	26	27	28	29	30	31



Piano induzione

Induction hob

Comodissimo PATENT



Piano a induzione cordless composto da due zone cottura, alimentato da una performante batteria al litio (potenza 1,5 kwh) che assicura un utilizzo di 60 minuti. Su ruote, senza limitazioni di cavi e prese elettriche, è facilmente spostabile in qualsiasi contesto indoor e outdoor. Con telaio in metallo e piani in legno di rovere, per la sua leggerezza e facilità di movimento Comodissimo è adatto sia per la casa che per il mondo della ristorazione professionale.

A cordless induction hob composed of two cooking plates, powered by a performing lithium battery (1.5 kwh) ensuring 60 minutes of utilisation. This is on wheels, without cable and electric outlets' limits, easily movable in any kind of context indoor and outdoor. With metal frame and oak wood top, thanks to its lightness and ease in movements, Comodissimo is suitable either for the home or the world of professional catering.



Bancone



Mobile fisso con induzione full flex filo top abbinata al piano lavoro in legno di grandi dimensioni. Bancone è personalizzabile sia nella lunghezza sia nel posizionamento (a sinistra, centrale o a destra) del piano cottura. Disponibile in frassino, è possibile richiedere il legno verniciato con un colore a pantone. La struttura in metallo prevede due mensole sottostanti sempre in legno e può essere utilizzata per appoggiare gli utensili.

Fixed cabinet with full flex wire top induction combined with a large wooden worktop. The counter is customizable in length and in the positioning (left, central or right) of the hob. Available in ash, it is also possible to request the wood painted in a pantone color. The metal structure comes with two wooden underlying shelves, which can be used as support for kitchen utensils.





Tutto



Innovativa mini kitchen che racchiude in una dimensione molto contenuta tutti gli elettrodomestici necessari per le funzioni di lavaggio e cottura.

Il piano in legno è progettato per accogliere uno spazio dedicato alla preparazione, un miscelatore per l'erogazione dell'acqua e un lavandino in acciaio, oltre a una pratica lava frutta/verdura che può fungere anche da lavastoviglie.

Il piano cottura a induzione è sospeso per meglio sfruttare lo spazio quando non è in uso: agganciate alla griglia sopra al top, le due piastre per la cottura possono essere appoggiate sul piano. Nella parte frontale trovano alloggio un cassetto refrigerante, cassette contenitori e un vano con ripiani in legno a vista.

Innovative compact kitchen unit enclosing all the necessary washing and cooking functions of household appliances in a very small size.

The wooden top is designed to host a dedicated space for the meal preparation, a blender for the water supply and a stainless steel sink, besides a practical cockpit fruit & vegetable washer that is also a little dishwasher.

The induction hob is hanging to better exploit the space when it is not in use: hooked to the grid above the top, the two cooking plates can be leaned on the wooden top and on the lid of the fruit & vegetable washer. On Tutto's frontal part are housed a cooling drawer, drawer-holders and a compartment with open wooden shelves.

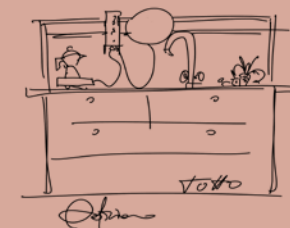



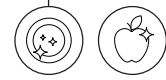

La pratica lava frutta/verdura a pozzetto, a seconda del programma impostato, è anche una piccola lavastoviglie.

The practical cockpit fruit & vegetable washer, according to the selected program, is also a little dishwasher.



Il cassetto refrigerante è adatto sia come cantinetta per le bottiglie sia come mini frigo per alimenti e pietanze.

The cooling drawer is suitable either as a wine cellar or a mini-fridge for food and courses.



Mammamia



L'induzione integrata filo-top permette di cucinare e/o terminare le cotture direttamente al tavolo.

Il piano ospita infatti due piastre a induzione inserite a filo spessore e comandate da un display posizionato nel centro.

La struttura è realizzata in acciaio con gambe in legno di rovere massello e piano personalizzabile in gres porcellanato, marmo, legno o vetro.

The integrated flush-top induction allows to cook and/or complete the cooking directly on the table. The table hosts two induction plates embedded flush in the top and controlled by a display placed on the centre.

The structure is made in steel with solid oak wooden legs and customizable table top in porcelain stoneware, marble, wood or glass.

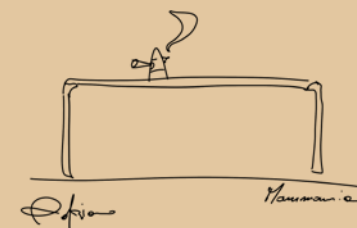





Piano in vetro nero, Induzione a scomparsa.
Colori: full black.
Gambe in rovere.

Black glass top, concealed induction hobs.
Colors: full black.
Oak legs.



Piano in Mdi by Inalco, induzione a scomparsa.
Colori: Materia Gris, Materia Taupe, Materia Muschio, Materia Antracite.
Gambe in rovere

Top in Mdi by Inalco, concealed induction hobs.
Colors: Materia Gris, Materia Taupe, Materia Muschio, Materia Antracite.
Oak legs.

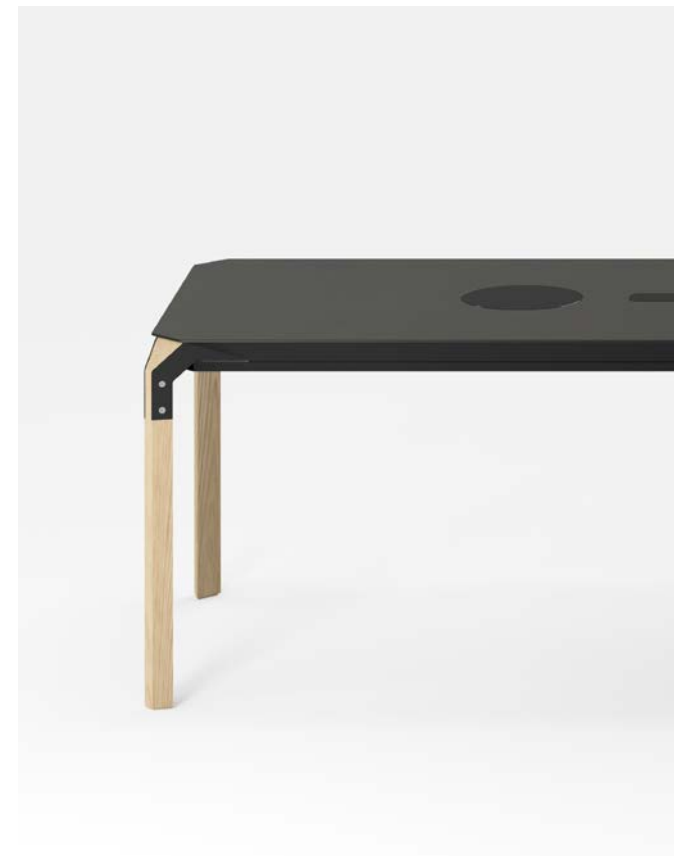

Piano in gres porcellanato, induzione integrata.
Colori: Statuario Reale Opaco, Statuario Reale Lucido, Calacatta Oro Opaco,
Calacatta Oro Lucido, Ardesia. Gambe in rovere.

Porcelain stoneware top, integrated induction hobs.
Colors: Statuario Reale Opaco, Statuario Reale Lucido, Calacatta Oro Opaco,
Calacatta Oro Lucido, Ardesia. Oak legs.

Cucinotta



Col suo grande “occhio” e la leggera struttura, questo piccolo mobile dall’aspetto simpatico raccoglie tutte le funzioni del cucinare diventando un compagno della quotidianità: essenziale e compatta, Cucinotta può essere facilmente collocata in diverse situazioni e trasportata tra gli ambienti. Meno di mezzo metro quadrato per la mini-kitchen con piano a induzione e cappa, completati da un capiente cassetto. Cappa e cassetto laccati bianchi, struttura in legno di frassino.

With its large “eye” and slender legs, this small eye-catching piece of furniture combines all the functions of cooking, thus becoming your “ally” in everyday life: essential and compact, Cucinotta can be easily placed in different contexts and moved from one room to another. Less than half a square meter for the mini-kitchen with induction hob and hood, completed with a large drawer. White lacquered hood and drawer, structure in ash wood.

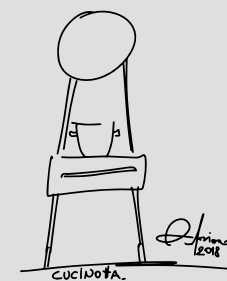



Ricarica Wireless integrata
sul piano cottura

Wireless charging integrated
on the hob



Enigma



Dov'è la cappa?

Una soluzione di design innovativa la fa sparire magicamente.

La mensola lineare funge solo da superficie di aspirazione e per questo è sottilissima; l'aria viene convogliata verso i due vasi in ceramica appoggiati sopra, che nascondono il motore e la parte elettronica.

La mensola di legno, in diverse essenze e colori disponibili su richiesta, può essere prolungata con altre in corrispondenza e i vasi sono forniti in terracotta, per massimizzare l'opera di mimetizzazione e abbinarsi alla palette e ai materiali scelti per l'ambiente.

La cappa è dotata di luce Led.

Where's the hood?

An innovative design solution makes it magically disappear.

The linear shelf only serves as an aspiration surface and for this reason it is very thin; the air is conveyed to the two ceramic vases placed on the top, which hide the motor and the electronics.

The wooden shelf, available on request in different wood essences and colors, can be extended with other corresponding shelves, while vases are supplied in terracotta, to maximize the camouflage effect and match the palette and materials chosen for the environment.

The hood is equipped with Led light.

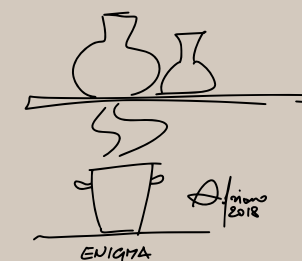



I vasi in terracotta della cappa sono forniti dall'azienda in materiale neutro e possono essere dipinti dall'utente in base alle proprie esigenze (ad esempio della stessa tonalità del muro). Qui alcuni esempi di colorazioni possibili.

The terracotta pots of the hood are supplied by the company in raw material and can be painted by the user according to their needs (for example in the same shade as the wall). Here are some examples of possible colors.



Epoca



Sottile e minimalista, la cappa a muro può essere inserita in qualsiasi contesto architettonico, domestico, professionale o ibrido. L'aspirazione/filtrazione avviene perimetralmente e tutte le funzioni sono comandate dalla comoda manopola rotativa che offre una gestione semplice e immediata, innestando un elemento analogico su un prodotto dal carattere tecnico ed essenziale. La cappa è dotata di luce Led.

Thin and minimalist, the wall hood can be installed in any architectural, domestic, professional or hybrid context. Evacuation/recirculation is perimetral and all functions are controlled by a user-friendly rotary knob for quick management of the hood: an analogue element inserted into a product with both a technical and essential character. The hood is equipped with Led light.

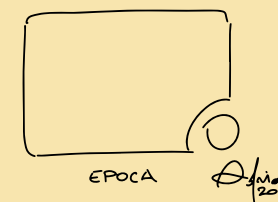



Linea



La cornice in legno dai bordi arrotondati descrive il profilo di aspirazione/filtrazione e può essere customizzata scegliendo l'essenza e il colore del legno per abbinarla con il progetto di interior.

La cappa a muro diventa così un elemento di arredo sottile e poco invadente, che combina funzionalità ed efficienza con un'immagine calda adatta per l'inserimento in ambienti residenziali o collettivi dedicati all'accoglienza.

Comandi touch chiari e di facile utilizzo posizionati frontalmente.

La cappa è dotata di luce Led.

The rounded edge wooden frame outlines the evacuation/recirculation profile and it can be customized by choosing the wood essence and color to match the interior design of any kitchen.

The wall hood thus becomes a subtle and unobtrusive piece of furniture, which combines functionality and efficiency with a warm and cozy feeling that fits perfectly into residential or collective environments dedicated to hospitality.

Clear and easy-to-use touch controls positioned on the front side.

The hood is equipped with Led light.

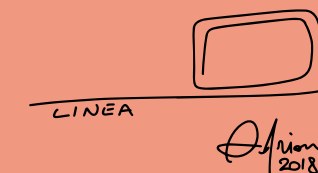



Cassetta



Con un semplice scorrimento la cappa si allunga quanto necessario per catturare i fumi di cottura, rientrando poi nella posizione di partenza.

Il movimento e la funzionalità sono resi possibili da un gesto intuitivo e anche un po' magico: la velocità di aspirazione aumenta infatti in base a quanto la cappa viene "tirata" verso di sé.

Con la sua composizione geometrica che abbina struttura in legno, copertura anteriore finitura Grigio titanio e scheletro in metallo, occupa poco spazio sul piano cottura quando non in funzione e può diventare un'utile barra attrezzabile.

La cappa è dotata di luce Led.

The hood slides and extends as much as necessary to capture cooking fumes, and then returns back to the starting position.

Movement and operation are made possible thanks to an intuitive gesture, which is also a little bit magical: the speed increases depending on how much the hood is "pulled" towards you.

Thanks to its geometric design combining a wooden structure, front cover and metal body, it takes up little space on the hob when not in use and it can serve as a useful tool bar.

The hood is equipped with Led light.

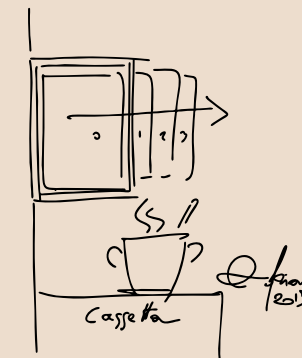



Pura



La costruzione “modulare” della cappa consente di scegliere le dimensioni (altezza e larghezza) a seconda delle esigenze: profili di alluminio di diversa lunghezza si inseriscono negli angolari formando un cubo o un parallelepipedo con facce in vetro. Un prodotto sartoriale che offre diverse possibilità di configurazione permettendo realizzazioni su misura. Comandi touch posizionati frontalmente. La cappa è dotata di luce Led.

The hood’s “modular” design allows you to choose the dimensions (height and width) according to your needs: aluminum profiles of different length are inserted into the corner elements to form a cube or a parallelepiped with glass facets. A tailor-made product that offers various possibilities of configuration to customize your own creation. The hood is equipped with LED light.

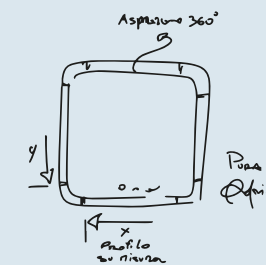





Cappa

Cooker hood

Pura Isola



Pura è disponibile anche in versione sospesa a isola.

Pura is also available in a suspended "Isola" version.



nero/bianco puro



nero/champagne



nero/arancione



nero/nero

Induction hob Induzione	Ordine	94
	Ordine Mono	95
	Ordine Isola	95
	Sorpresa	96
	Ribalto	97
	Eccolo	98
	Comodo	99
	Comodo XL	99
	Comodissimo	99
	Bancone	100
	Tutto	101
	Mammamia	102

Induzione e cappa Induction hob and cooker hood	Cucinotta	103
--	-----------	-----

Cappa Cooker hood	Enigma	104
	Epoca	105
	Linea	106
	Cassetta	107
	Pura	108
	Pura Isola	108

Ordine

Caratteristiche/ Features

Finitura Vetro/
Glass finish: Bianco/White, Nero/Black, Legno/Wood

Colore bordo zona cottura/
Color ring cooking zone: Cromato/Chrome

Ring per finitura in legno/
Ring for wood finish: Rame/Copper

Dimensioni (mm)/
Dimensions (mm): 257x257

N.zone induzione/
N.induction zone: 2

Livelli potenza/
Power setting: 9

Comandi/
Controls: Touch/Touch

Potenza totale (W)/
Total power (W): 3.600

Ordine Black disponibile anche a 2.800
Ordine Black also available in 2.800

Voltaggio (V)/
Voltage (V): 220-240

Frequenza (Hz)/
Frequency (Hz): 50/60

Funzioni/ Functions

Power Management System/
Power Management System: No/No

Sicurezza bambini/
Child Lock: Si/Yes

Protezione Spegnimento Automatico/
Automatic Power-off: Si/Yes

Protezione calore residuo/
Residual Heat Protection: Si/Yes

Spegnimento Automatico/
Automatic Shutdown: Si/Yes

Booster/
Booster: No/No

Timer/
Timer: Si/Yes

Pause-Recall/
Pause-Recall: Si/Yes

Chef cook/
Chef cook: No/No

Bridge/
Bridge: No/No

Potenza zona cottura/ Power cooking zone

Zona cottura Dx (W)/
Cooking zone Right (W): 1.400 / 1.800

Zona cottura Sx (W)/
Cooking zone Left (W): 1.400 / 1.800



Ordine Bianco / Inox | 26962



Ordine Bianco | 26065



Ordine Bianco / Ottone | 26969



Ordine Leopard | 26968



Ordine Lion | 26967



Ordine Zebra | 26966



Ordine Bianco / Wood / Inox | 26964



Ordine Nero / Wood / Rame | 26963



Ordine Nero / Ghisa | 26970



Ordine Nero / Ottone | 26971



Ordine Nero / Rame | 26963



Ordine Nero / Inox | 26960
Ordine Nero / Inox 2.8Kw | 26959

Ordine Mono

Caratteristiche/ Features

Finitura Vetro/
Glass finish: Nero/Black

Colore bordo zona cottura/
Color ring cooking zone: Cromato/Chrome

Dimensioni (mm)/
Dimensions (mm): 257x257

N.zone induzione/
N.induction zone: 1

Livelli potenza/
Power setting: 9

Comandi/
Controls: Touch/Touch

Potenza totale (W)/
Total power (W): 1.800

Voltaggio (V)/
Voltage (V): 220-240

Frequenza (Hz)/
Frequency (Hz): 50/60

Funzioni/ Functions

Power Management System/
Power Management System: No/No

Sicurezza bambini/
Child Lock: Si/Yes

Protezione Spegnimento Automatico/
Automatic Power-off: Si/Yes

Protezione calore residuo/
Residual Heat Protection: Si/Yes

Spegnimento Automatico/
Automatic Shutdown: Si/Yes

Booster/
Booster: No/No

Timer/
Timer: Si/Yes

Pause-Recall/
Pause-Recall: Si/Yes

Chef cook/
Chef cook: No/No

Bridge/
Bridge: No/No

Potenza zona cottura/ Power cooking zone

Zona cottura (W)/
Cooking zone (W): 1.800

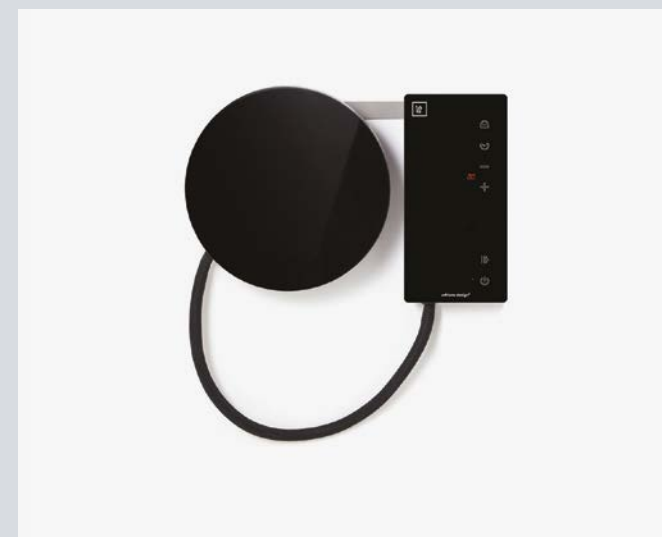

Ordine Black 1 piastra/one plate 1,8 Kwh | 26492

Accessorio/ Accessory



Acciaio Inox /
Steel



Acciaio verniciato nero /
Steel painted black

Ordine Isola

Accessorio/ Accessory



Consolle Frassino/Ash Consolle | 26082
Consolle Noce scuro/Dark Walnut Consolle | 26112
Consolle Acciaio/Steel Consolle | 26594
Consolle Nera/Black Consolle | 26595

Sorpresa

Caratteristiche/ Features

Finitura zone cottura/
Cooking zone finishes: Vetro nero /Black glass
Gres porcellanato / Gres

Colore bordo zona cottura/
Color ring cooking zone: Nero/Black

Finitura basamento/
Basement finish: Legno Frassino naturale/
Natural Ash wood

Dimensione zone cottura/
Cooking zone size: Ø 200, 160, 145 mm

Dimensione display/
Cooking zone size: 250 × 80 × 22 mm

Dimensione base legno/
Wood base dimension: 410 × 121 × 60 mm

N.zone induzione/
N.induction zone: 3

Livelli potenza/
Power setting: 9 + Booster

Comandi/
Controls: Touch/Touch

Potenza totale (W)/
Total power (W): 7.200

Voltaggio (V)/
Voltage (V): 220-240

Frequenza (Hz)/
Frequency (Hz): 50/60

Funzioni/ Functions

Power Management System/
Power Management System: Si/Yes

Sicurezza bambini/
Child Lock: Si/Yes

Protezione Spegnimento Automatico/
Automatic Power-off: Si/Yes

Protezione calore residuo/
Residual Heat Protection: Si/Yes

Spegnimento Automatico/
Automatic Shutdown: Si/Yes

Booster/
Booster: Si/Yes

Timer/
Timer: Si/Yes

Pause-Recall/
Pause-Recall: Si/Yes

Chef cook/
Chef cook: Si/Yes

Bridge/
Bridge: No/No

Potenza zona cottura/ Power cooking zone

Zona cottura Basso (W)/
Cooking zone Lower (W): 2.100 (3.000)

Zona cottura Alto (W)/
Cooking zone Up (W): 2.100 (3.000)



Sorpresa | 27033

Ribalto

Caratteristiche/ Features

Finitura Vetro/Glass finish: Nero/Black

Colore bordo zona cottura/
Color ring cooking zone: Acciaio Inox
Stainless steel

Dimensioni Piano cottura /
Dimensions Hob: 536 × 279 × h30 mm

Dimensioni Potenza /
Dimensions Power unit: 502 × 279 × 44 mm

Dimensioni incasso/
Recess dimensions: N/a

N.zone induzione/
N.induction zone: 2

Livelli potenza/Power setting: 9

Comandi/Controls: Touch/Touch

Potenza totale (W)/Total power (W): 3.700

Voltaggio (V)/Voltage (V): 220-240

Frequenza (Hz)/Frequency (Hz): 50/60

Funzioni/ Functions

Power Management System/
Power Management System: Si/Yes

Sicurezza bambini/
Child Lock: Si/Yes

Protezione Spegnimento Automatico/
Automatic Power-off: Si/Yes

Protezione calore residuo/
Residual Heat Protection: Si/Yes

Spegnimento Automatico/
Automatic Shutdown: Si/Yes

Booster/
Booster: Si/Yes

Timer/
Timer: Si/Yes

Pause-Recall/
Pause-Recall: Si/Yes

Chef cook/
Chef cook: No/No

Bridge/
Bridge: Si/Yes

Potenza zona cottura/ Power cooking zone

Zona cottura Basso (W)/
Cooking zone Lower (W): 2.100 (3.000)

Zona cottura Alto (W)/
Cooking zone Up (W): 2.100 (3.000)



Ribalto | 26647

Versione 2 fuochi/ 2 burners version



Versione 2+2 fuochi

Eccolo

Caratteristiche/ Features

Finitura/
Finish: Vetro nero /Black glass
Alluminio / Aluminium

Colore bordo zona cottura/
Color ring cooking zone: Cromato/Chrome

Dimensioni/
Dimensions: 333, 5 mm

N.zone induzione/
N.induction zone: 1

Livelli potenza/
Power setting: 9

Comandi/
Controls: Manopola/Knob

Potenza totale (W)/
Total power (W): 1800

Voltaggio (V)/
Voltage (V): 220-240

Frequenza (Hz)/
Frequency (Hz): 50/60

Funzioni/ Functions

Power Management System/
Power Management System: No/No

Sicurezza bambini/
Child Lock: No/No

Protezione Spegnimento Automatico/
Automatic Power-off: Si/Yes

Protezione calore residuo/
Residual Heat Protection: Si/Yes

Spegnimento Automatico/
Automatic Shutdown: Si/Yes

Booster/
Booster: No/No

Timer/
Timer: Si/Yes

Pause-Recall/
Pause-Recall: Si/Yes

Chef cook/
Chef cook: No/No

Bridge/
Bridge: No/No

Potenza zona cottura/ Power cooking zone

Zona cottura (W)/
Cooking zone (W): 1.800



Eccolo | 27032

Comodo Comodo XL Comodissimo

Caratteristiche/ Features

Finitura Vetro/
Glass finish: Nero/Black

Dimensioni/
Dimensions: Comodo: 450×450×900 mm
Comodo XL: 900×450×900 mm
Comodissimo: 900×450×900 mm

N.zone induzione/
N.induction zone: 2

Livelli potenza/
Power setting: 9

Comandi/
Controls: Touch/Touch

Potenza totale (W)/
Total power (W): 3.700

Voltaggio (V)/
Voltage (V): 220-240

Frequenza (Hz)/
Frequency (Hz): 50/60

Funzioni/ Functions

Power Management System/
Power Management System: Si/Yes

Sicurezza bambini/
Child Lock: Si/Yes

Protezione Spegnimento Automatico/
Automatic Power-off: Si/Yes

Protezione calore residuo/
Residual Heat Protection: Si/Yes

Spegnimento Automatico/
Automatic Shutdown: Si/Yes

Booster/
Booster: Si/Yes

Timer/
Timer: Si/Yes

Pause-Recall/
Pause-Recall: Si/Yes

Chef cook/
Chef cook: No/No

Bridge/
Bridge: Si/Yes

Potenza zona cottura/ Power cooking zone

Zona cottura Basso (W)/
Cooking zone Lower (W): 2.100 (3.000)

Zona cottura Alto (W)/
Cooking zone Up (W): 2.100 (3.000)



Comodo | 26115



Comodo XL | 26116



Comodissimo | 27034

Bancone

Caratteristiche/ Features	
Finitura Vetro/ Glass finish:	Nero/Black (1.000×600 mm)
Dimensioni (mm)/ Dimensions (mm):	3.000×600×900
Dimensioni incasso (mm)/ Recess dimensions (mm):	1.000×600
N.zone induzione/ N.induction zone:	6
Livelli potenza/ Power setting:	9
Comandi/ Controls:	Touch/Touch
Potenza totale (W)/ Total power (W):	11.400
Voltaggio (V)/ Voltage (V):	220–240
Frequenza (Hz)/ Frequency (Hz):	50/60

Funzioni/ Functions	
Power Management System/ Power Management System:	Si/Yes
Sicurezza bambini/ Child Lock:	Si/Yes
Protezione Spegnimento Automatico/ Automatic Power-off:	Si/Yes
Protezione calore residuo/ Residual Heat Protection:	Si/Yes
Spegnimento Automatico/ Automatic Shutdown:	Si/Yes
Booster/ Booster:	Si/Yes
Timer/ Timer:	Si/Yes
Pause-Recall/ Pause-Recall:	Si/Yes
Chef cook/ Chef cook:	Si/Yes
Bridge/ Bridge:	Si/Yes

Potenza zona cottura/ Power cooking zone	
Zona cottura Destra (W)/ Cooking zone Right (W):	Full Flexi
Zona cottura Sinistra (W)/ Cooking zone Left (W):	Full Flexi

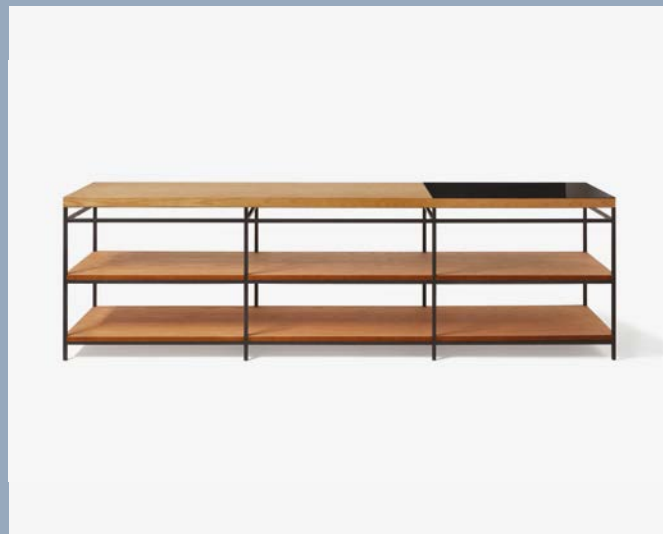

Bancone – area cooking 100 cm | 26364

Prodotto interamente personalizzabile, tempi e prezzo su richiesta / Fully customizable product, times and costs on request

Disponibile in frassino, è possibile richiedere legno verniciato con un colore a pantone, è possibile installare qualsiasi tipologia di piano cottura a induzione. Struttura in metallo 20x20 mm / Available in ash, it is possible to require the painted wood with Pantone colour, it is possible to install any type of induction hob. 20x20 mm metal structure

Tutto

Caratteristiche lavastoviglie Dishwasher features/	
Configuration	Hot air drying, bowl rack 1, 1 basket
Panel material/color	tempered glass (black) 4 mm
Sink material/process	Food grade 304 stainless steel/ hand tank
Voltaggio (V)/ Voltage (V):	220V–240V 50Hz/60HZ
Power Potenza	1840 W
N.W/G.W	39.5 Kg / 47 Kg
Normal operating water pressure	0.1MPa–1.0MPa
Washing pump	Eco integrated heating and washing pump
Drainage way	Strong platoon
Drying methods	PTC heating/turbofan
Kitchen counter opening size	1070×470 mm
Power consumption	Quick wash 0.58kwh/ standard wash 0.74kwh/ power wash 1.05kwh
Washing temperature/time	Quick wash 70° (26min) Standard wash 60°(65min) Strong wash 75°(80min) Self-clean 60°(20min)
Drying time	45min
Control buttons	Standard, strong, quick wash, self clean, ingredients, water level, start/pause, power button
Rinse way	Spray type
Tableware to receive	6 sets (2 deep dishes, 2 shallow basins, 1 large soup bowl, 1 fish plate, 6 rice bowls, 1 large soup spoon, 6 pairs of chopsticks, 6 soup spoons)

Fridge Drawer features/ Caratteristiche cassetto frigo	
Bottle loading Capacità bottiglie	5 Bottles of Burgundy
Energy Class Classe energetica	G
Temperature Range Range temperatura	5–18 c°
Control in Cabinet Controllo	On Door Frame
Door Frame Cornice porta	Iron Frame
Shelf Scaffale	1 pcs Black SST plate
Rail	Yes
LED Light Luce LED	White



Tutto – L. 150 cm: Ordine, Lav + Lavastoviglie, Miscelatore acciaio, Frigo, Top rovere, ante bianco | 27035

Tutto – L. 150 cm: Ordine, Lav + Lavastoviglie, Miscelatore acciaio, Frigo, Top frassino, ante bianco | 27037

Tutto – L. 150 cm: Ordine, Lavello, Miscelatore (pvd gun metal), Frigo, Top rovere, ante bianco | 27039

Tutto – L. 150 cm: Ordine, Lavello, Miscelatore (pvd gun metal), Frigo, Top frassino, ante bianco | 27041

Tutto – L. 180 cm: Ordine, Lav + Lavastoviglie, Miscelatore acciaio, Frigo, Top rovere, ante bianco | 27036

Tutto – L. 180 cm: Ordine, Lav+Lavastoviglie, Miscelatore acciaio, Frigo, Top frassino, ante bianco | 27038

Tutto – L. 180 cm: Ordine, Lavello, Miscelatore (pvd gun metal), Frigo, Top rovere, ante bianco | 27040

Tutto – L. 180 cm: Ordine, Lavello, Miscelatore (pvd gun metal), Frigo, Top frassino, ante bianco | 27042

An all-in-one mini kitchen composed by multiple elements, it can be purchased in different configurations.

Una mini cucina all-in-one composta da più elementi e acquistabile in diverse configurazioni.

* When bought without dishwasher is provided with a 50 cm sink and a PVD mixer “Tasca”.

* Quando acquistato senza lavastoviglie è dotato di un lavabo da 50 cm e un mixer pvd “Tasca”.

ELEMENTS:
– Ordine (see specs at page 94)
– Dishwasher*
– Fridge drawer

ELEMENTS:
– Ordine (see specs at page 94)
– Lavastoviglie*
– Cassetto frigo

Mammamia

Caratteristiche/ Features

Finitura/ Finish:	Vetro, Inalco, Gres
----------------------	---------------------

Dimensioni (mm)/ Dimensions (mm):	2210×860×80
--------------------------------------	-------------

N.zone induzione/ N.induction zone:	2
--	---

Livelli potenza/ Power setting:	9+P
------------------------------------	-----

Comandi/ Controls:	Touch
-----------------------	-------

Potenza totale (W)/ Total power (W):	3.700
---	-------

Ordine Black disponibile anche a 2.800
Ordine Black also available in 2.800

Voltaggio (V)/ Voltage (V):	220-240
--------------------------------	---------

Frequenza (Hz)/ Frequency (Hz):	50/60
------------------------------------	-------

Funzioni/ Functions

Power Management System/ Power Management System:	Si/Yes
--	--------

Sicurezza bambini/ Child Lock:	Si/Yes
-----------------------------------	--------

Protezione Spegnimento Automatico/ Automatic Power-off:	Si/Yes
--	--------

Protezione calore residuo/ Residual Heat Protection:	Si/Yes
---	--------

Spegnimento Automatico/ Automatic Shutdown:	Si/Yes
--	--------

Booster/ Booster:	Si/Yes
----------------------	--------

Timer/ Timer:	Si/Yes
------------------	--------

Pause-Recall/ Pause-Recall:	Si/Yes
--------------------------------	--------

Chef cook/ Chef cook:	No/No
--------------------------	-------

Bridge/ Bridge:	No/No
--------------------	-------

Potenza zona cottura/ Power cooking zone

Zona cottura Dx (W)/ Cooking zone Right (W):	2.300 / 3.000
---	---------------

Zona cottura Sx (W)/ Cooking zone Left (W):	2.300 / 3.000
--	---------------



Mammamia - Vetro | 27044



Mammamia - Inalco | 27043



Mammamia - Gres | 27052

Cucinotta

Caratteristiche/ Features

Finitura Vetro/ Glass finish:	Nero/Black
----------------------------------	------------

Dimensioni (mm)/ Dimensions (mm):	1949×570×843
--------------------------------------	--------------

N.zone induzione/ N.induction zone:	2
--	---

Livelli potenza/ Power setting:	9
------------------------------------	---

Comandi/ Controls:	Touch/Touch
-----------------------	-------------

Potenza totale (W)/ Total power (W):	3.600
---	-------

Voltaggio (V)/ Voltage (V):	220-240
--------------------------------	---------

Frequenza (Hz)/ Frequency (Hz):	50/60
------------------------------------	-------

Funzioni/ Functions

Power Management System/ Power Management System:	Si/Yes
--	--------

Sicurezza bambini/ Child Lock:	Si/Yes
-----------------------------------	--------

Protezione Spegnimento Automatico/ Automatic Power-off:	Si/Yes
--	--------

Protezione calore residuo/ Residual Heat Protection:	Si/Yes
---	--------

Spegnimento Automatico/ Automatic Shutdown:	Si/Yes
--	--------

Booster/ Booster:	Si/Yes
----------------------	--------

Timer/ Timer:	Si/Yes
------------------	--------

Pause-Recall/ Pause-Recall:	No/No
--------------------------------	-------

Chef cook/ Chef cook:	No/No
--------------------------	-------

Bridge/ Bridge:	No/No
--------------------	-------

Potenza zona cottura/ Power cooking zone

Zona cottura Frontale (W)/ Cooking zone Front (W):	1.200 (1.600)
---	---------------

Zona cottura Posteriore (W)/ Cooking zone Rear (W):	1.500 (2.000)
--	---------------

Caratteristiche cappa/ Hood Features

Dimensioni Cappa (mm)/ Hood Size (mm):	Ø 598 Smussato/Bevelled
---	-------------------------

Finitura/ Finish:	Corpo cappa bianco/White Hood Body
----------------------	------------------------------------

Vetro finitura/ Glass finish:	Nero/Black
----------------------------------	------------

N°Velocità/ N° velocity:	3+1
-----------------------------	-----

Luci/ Lights:	Led
------------------	-----

IEC Aspirazione (M3/H)/ IEC Intake (M3/H):	500
---	-----

Filtri/ Filters:	Alluminio+filtro a carbone/Aluminum+Coal Filter
---------------------	---

Rumorosità Db/ Noise Db:	60
-----------------------------	----

Carica Smartphone/ Smartphone Charger:	Diametro 80 mm/Diameter 80 mm 5 Volt/1 Ampere Standard Qi
---	--



Enigma

Caratteristiche/ Features

Dimensioni (mm)/
Dimensions (mm): 900x500

Dimensioni vasi (mm)/
Vases dimensions (mm): 494x166,5x450
494x112,5x683

Finitura/
Finish: Legno/Wood

Comandi/
Controls: Touch/Touch

Illuminazione/
Lighting: Led/Led

Filtro/
Filter: Alluminio/Mash

Uscita aria/
Of air outlet: 112x144,5

Larghezza (mm)/
Width (mm): 900

Funzioni/ Functions

Velocità/
Speed: 3+1

Capacità Aspirazione IEC (M3/H)/
Air Capacity IEC (M3/H): 490

Potenza assorbita (W)/
Absorbed power (W): 124

Rumorosità Db(A)/
Noise Level Db(A): 60

Classe energetica/
Energy level: A

Accessori/ Accessories

Prolunga 30cm/Extend 30cm:
Legno con Led/Wood with Led

Prolunga 90cm/Extend 90cm:
Legno con Led/Wood with Led



Enigma 90cm | 26345



Enigma 120cm | 26640

Prolunga 30cm /
Extend 30cm



Enigma 180cm | 26639

Prolunga 90cm /
Extend 90cm

Epoca

Caratteristiche/ Features

Dimensioni (mm)/
Dimensions (mm): 900x600x360

Finitura/
Finish: Nero/Black

Finitura vetro/
Glass finish: Nero/Black

Comandi/
Controls: Manopola/Knob

Illuminazione/
Lighting: Led/Led

Filtro/
Filter: Alluminio/Mash

Uscita aria/
Of air outlet: 150

Larghezza (mm)/
Width (mm): 900

Funzioni/ Functions

Velocità/
Speed: 3+1

Capacità Aspirazione IEC (M3/H)/
Air Capacity IEC (M3/H): 779

Potenza assorbita (W)/
Absorbed power (W): 278

Rumorosità Db(A)/
Noise Level Db(A): 57

Classe energetica/
Energy level: A



Epoca | 26083

Linea

Caratteristiche/ Features

Dimensioni (mm)/
Dimensions (mm): 900x600x320

Finitura/
Finish: Nero/Black

Finitura vetro/
Glass finish: Nero/Black

Comandi/
Controls: Touch/Touch

Illuminazione/
Lighting: Led/Led

Filtro/
Filter: Alluminio/Mash

Uscita aria/
Of air outlet: 150

Larghezza (mm)/
Width (mm): 900

Funzioni/ Functions

Velocità/
Speed: 3+1

Capacità Aspirazione IEC (M3/H)/
Air Capacity IEC (M3/H): 779

Potenza assorbita (W)/
Absorbed power (W): 220-240

Rumorosità Db(A)/
Noise Level Db(A): 57

Classe energetica/
Energy level: A



Linea | 26085

Disponibile con cornice in legno grezzo verniciabile/
Available with paintable rough wooden frame

Cassetta

Caratteristiche/ Features

Dimensioni/
Dimensions: Chiusa/Close: 600x700x450 mm
Aperta/Open: 600x700x550 mm

Finitura/
Finish: Legno frassino e ferro/Ash wood and iron

Comandi/
Controls: A scorrimento con microswitch/
micro miniature slide switch

Illuminazione/
Lighting: Led/Led

Filtro/
Filter: Alluminio/Mash

Uscita aria/
Of air outlet: 150

Larghezza (mm)/
Width (mm): 600

Funzioni/ Functions

Velocità/
Speed: 3+1

Capacità Aspirazione IEC (M3/H)/
Air Capacity IEC (M3/H): 779

Potenza assorbita (W)/
Absorbed power (W): 278

Rumorosità Db(A)/
Noise Level Db(A): 57

Classe energetica/
Energy level: A



Cassetta | 26411



Pura

Pura isola

Caratteristiche/ Features

Dimensioni (mm)/
Dimensions (mm): 430x430x430

Finitura/
Finish: Vetro-Alluminio/Glass-Alluminium

Finitura vetro/
Glass finish: Nero/Black

Comandi/
Controls: Electronic Touch/Electronic Touch

Illuminazione/
Lighting: Led/Led

Filtro/
Filter: Alluminio/Mash

Uscita aria/
Of air outlet: 150

Larghezza (mm)/
Width (mm): 430

Funzioni/ Functions

Velocità/
Speed: 3+booster

Capacità Aspirazione IEC (M3/H)/
Air Capacity IEC (M3/H): 759

Potenza assorbita (W)/
Absorbed power (W): 278

Rumorosità Db(A)/
Noise Level Db(A): 47-68

Classe energetica/
Energy level: A



nero/bianco puro
pura parete 27028
pura isola 27025



nero/champagne
pura parete 27029
pura isola 27026



nero/arancione
pura parete 27027
pura isola 27024



nero/nero
pura parete 25917
pura isola 26930

Dimensionali Dimensionals



Ordine

Induzione / Induction Hob

630 x 440 x 59 mm

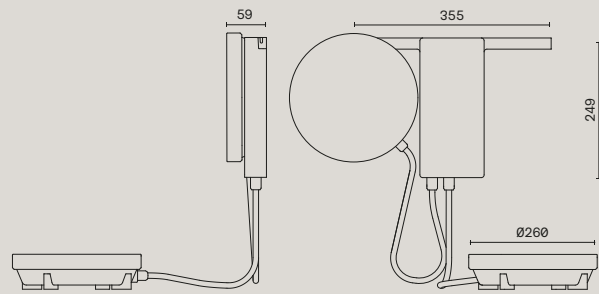

Accessorio / accessory

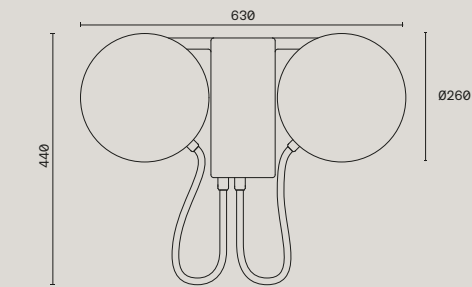
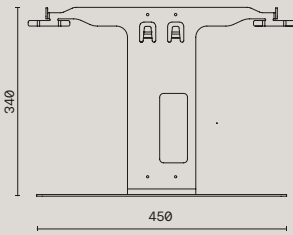

Accessorio / accessory

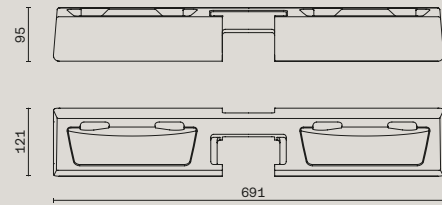

Fissaggio a parete/
Fissaggio a parete

Foratura dal top consigliata
Foratura dal top consigliata

400 — 450 mm

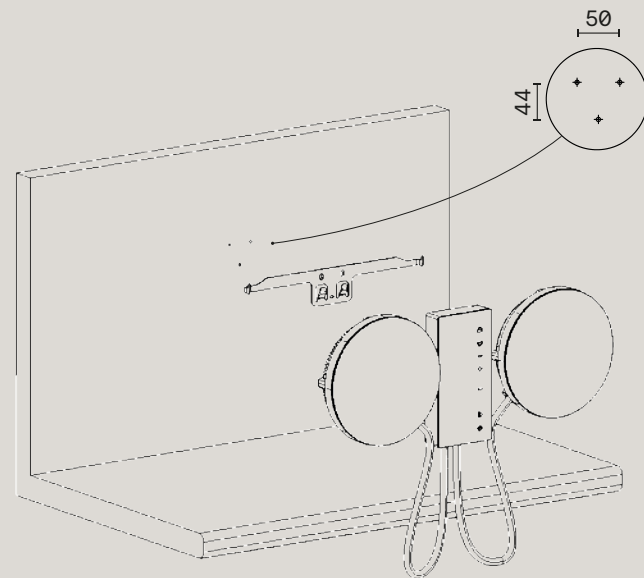

Eccolo

Induzione / Induction Hob

334 x 885 x 352 mm

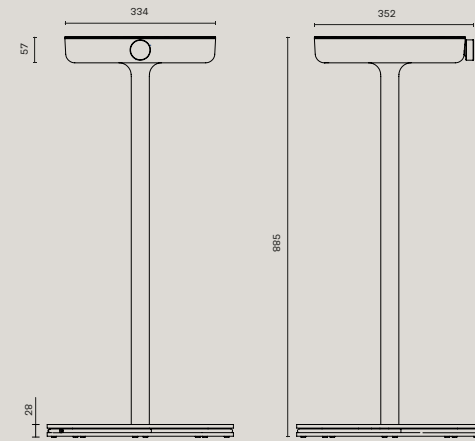

Ribalto

Induzione / Induction Hob

Dimensione Piano Cottura / Hob size
529 x 309 x 34 mm

Dimensione Potenza / Power unit size
502 x 279 x 44 mm

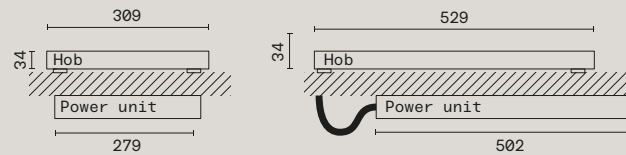

Sorpresa

Induzione / Induction Hob

480 x 325 x 250 mm

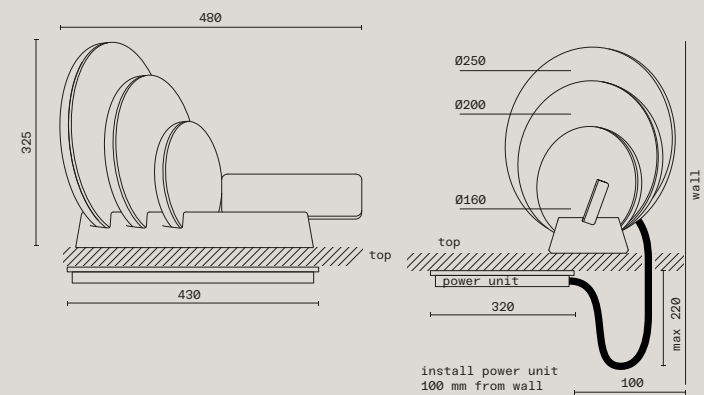

Schema d'installazione /
Installation Layout

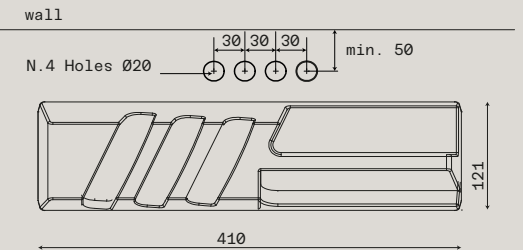

Schema d'installazione /
Installation Layout

- A Piano cottura sopra top /
Hob above the top
- B Staffa supporto potenza sotto top /
Power support bracket under the top
- C Power box

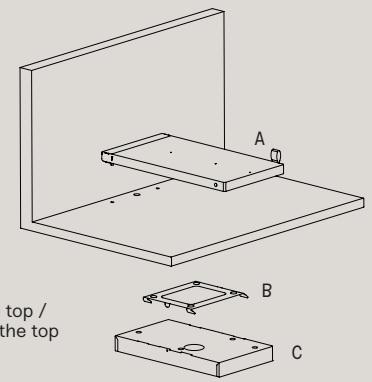

Forature per installazione /
Drilling for installation

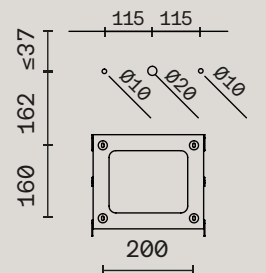

Quota minima da parete 37 mm /
Minimum distance from the wall 37mm

Comodo

Induzione / Induction Hob

450 x 450 x 900 mm

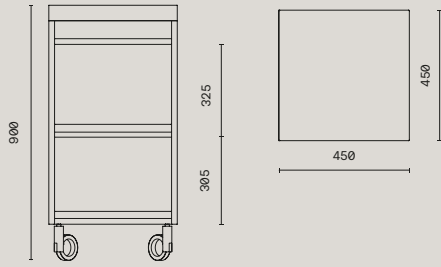

Comodo XL

Induzione / Induction Hob

900 x 450 x 900 mm

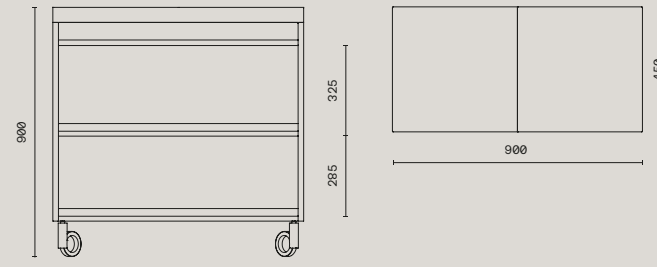

Tutto

Induzione / Induction Hob

1500/1800 x 600 x 900 mm

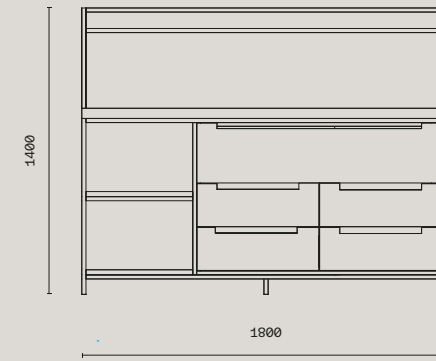

Mammamia

Induzione / Induction Hob

2.224 x 873 x 763 mm

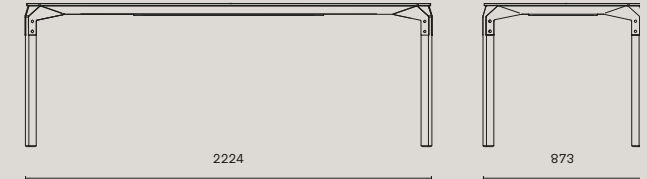

Comodissimo

Induzione / Induction Hob

900 x 450 x 900 mm

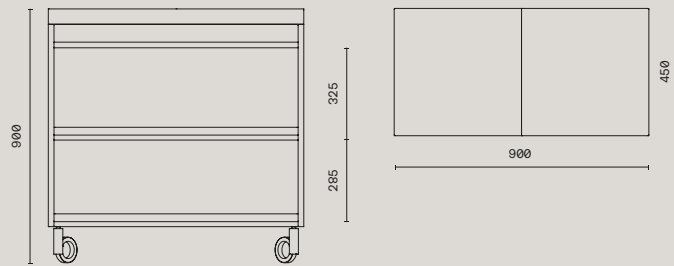

Bancone

Induzione / Induction Hob

3.000 x 600 x 900 mm
Custom made

Cucinotta

Induzione / Induction Hob

1.949 x 843 x 600 mm

Dimensioni piano cottura/
Hob dimensions:
550x550 mm

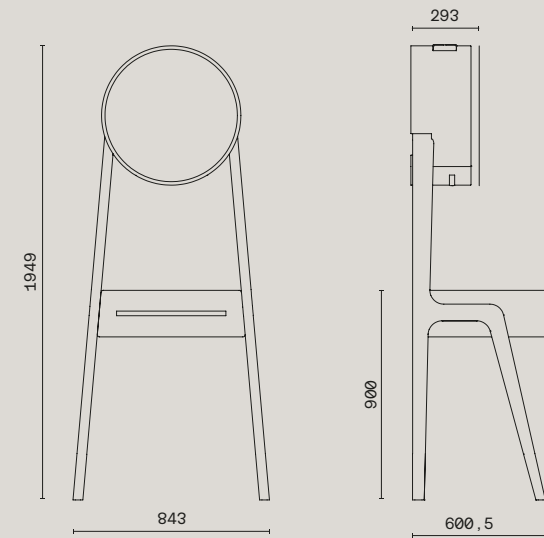

Enigma

Induzione / Induction Hob

900 x 728 x 500 mm

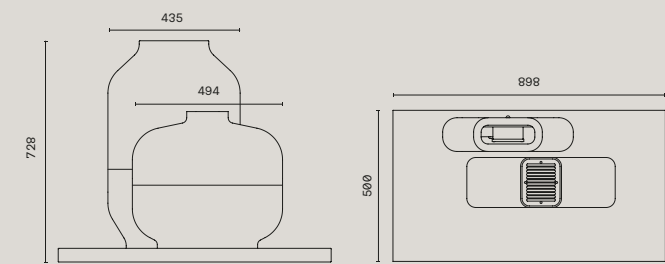

Epoca

Induzione / Induction Hob

900×600×360 mm

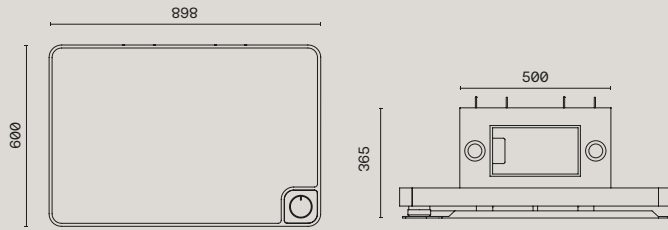

Linea

Induzione / Induction Hob

900×600×320 mm

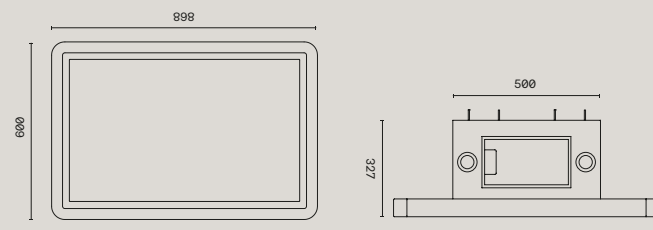

Cassetta

Induzione / Induction Hob

Chiusa/Close: 600×700×450 mm
Aperta/Open: 600×700×550 mm

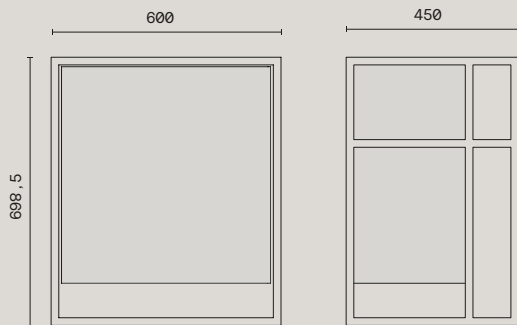

Pura

Induzione / Induction Hob

430×430×430 mm

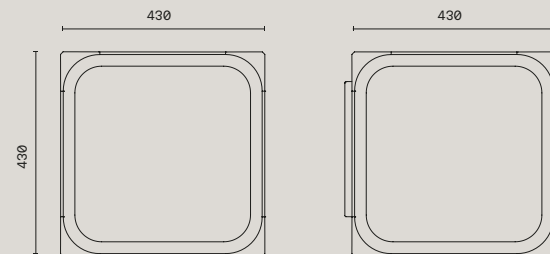

Fabita Srl

Offices and showroom
Via Vittorio Veneto 166
60044 Fabriano – Ancona
Italy

Production
Contrada Serralta 49/A
60048 Serra San Quirico – Ancona
Italy

Phone
+390731880300

Email
marketing@fabita.it

Fax
+390731880317

Website
www.fabita.it

Follow us



Customer Service
service@fabita.it
+390270808

Art Direction
Adriano Design
www.adriano.design.it

Graphic Design
Mauro Tittoto
www.mtttt.it

Editorial coordination
Evelina Bazzo / Umbrella | comunicare design

Media Relation
Umbrella | comunicare design
presso@umbrella.it

